

KSD-9007



SIZE: 170X90X215cm

Cautions in Installation and Using

Thanks for selecting our shower room series. To guarantee safe and normal operation as well as prolong service lifetime. Pls read Instruction carefully before installation.

Note: Constar is dedicated to improving products quality, find something new in what is old, we would if there is difference in the Instruction until further notice. Any discomfort, we ask your pardon.

Directory

1. Tool contents	-----	3
2. Accessory list	-----	4-6
3. Pipe and drain installation drawing	-----	7
4. Installation Procedure	-----	8-19
5. Notes	-----	20
6. Delivery and storage notice	-----	20
7. Trouble shootings	-----	21

(1)

7, Trouble shootings

Troble	Cause	Remedy
No power	1. Electric power don't connect well, leak swtich is cut off.	Access to power
	2. Fuse wire is broken, switch of control panel is failure.	Maintain or replace
	3. GFCI is out of work	Check GFCI
No head shower	1. water pressure is abnormal	Check water pressure
	2. Cold and hot water switch is closed.	Turn on the cold and hot water switch
	3. chocking nozzle	Clean
Water pipe leakage	1. Seal ring damaged	Replace seal ring
	2. Tie in don't connect well	Connect it again
No radio	1. Connecting wire is cut	Make connection
	2. Loudspeaker is broken	Replace a new one
Phone unuable	1. Telephone wire don't connect well	To make contact telephone line
	2. Control panel is broken	Maintain or replace
No light	1. Bulb is broken, ballast is broken	Replace
	2. Break of ballast	To make contact
	3. Control panel is broken	Maintain or replace
No exhaust	1. Fan is broken	Replace
	2. Tie-in is not connect well	To make contact
	3. Control panel is broken	Maintain or replace

If complete shower room cant work normally, please check it as compare above then obstacle avoidance.

If customers cant make sure the cause of obstacle or lack of ability mantianance. Please contact distributor.

(22)





5: Notes

1. It is unadvisable to take a shower after drunk.
2. It is unadvisable to have a shower immediately after acute sports.
3. Please avoid bath or shower in morning.
4. Keep the temperature of dressing room near to the bathroom's
5. If you feel uncomfortable while having a shower, you should go out of the shower room as soon as possible.
6. The time of shower is advisable to be between 15 minutes and 20 minutes, no longer.
7. Drink water to supplement moisture after shower or bathing.
8. People who suffer from heart disease, high blood pressure, diabetes or who feel unwell or pregnant woman are unadvisable to have bathing, massage or shower.



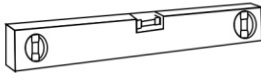

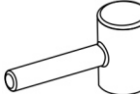
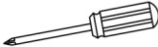

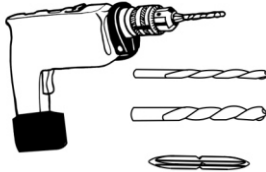

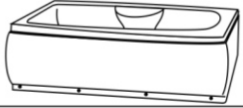

6: Delivery and storage notice

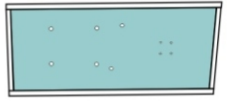
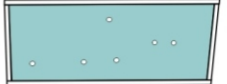
- 1, It is prohibited to store organic solvent together, such as formic acid and methanol.
2. Handle with care if it need transport. Heavy stress, mechanical impact and sharp pounding is prohibited.
3. It should keep it dry and airy and make sure there is no etchant gas.

1. self-provide tool

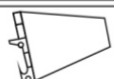
Name	Tool
Track level bar	
Tape measure	
Ajustable spanner	
Rubber hammer	
Phillips srewdriver	
Scissors	
Glass cement	
electric drill	
3mm aiguille	
6mm aiguille	
tap drill	

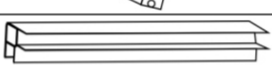
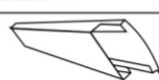
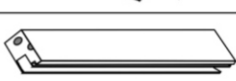
2. Partial accessory list

Item	Name	Accessory	Quantity
1	(1. 1) Tub		1
	(1. 2) Middle backboard		1
	(1. 3) Roof		1
2	(2. 1) backboard		1
	(2. 2) backboard		1
	(2. 3) Right backboard		2
	(2. 4) fixed door glass		2
	(2. 5) flexible door glass		2
3	(3. 1) Upper rail		1
	(3. 2) Bottom rail		1
	(3. 3) Outer side upright column		2
	(3. 4) Front upright column		2
	(3. 5) Side upright column		2
	(3. 6) Inner side upright column		2

(3)

4. Installation Procedure

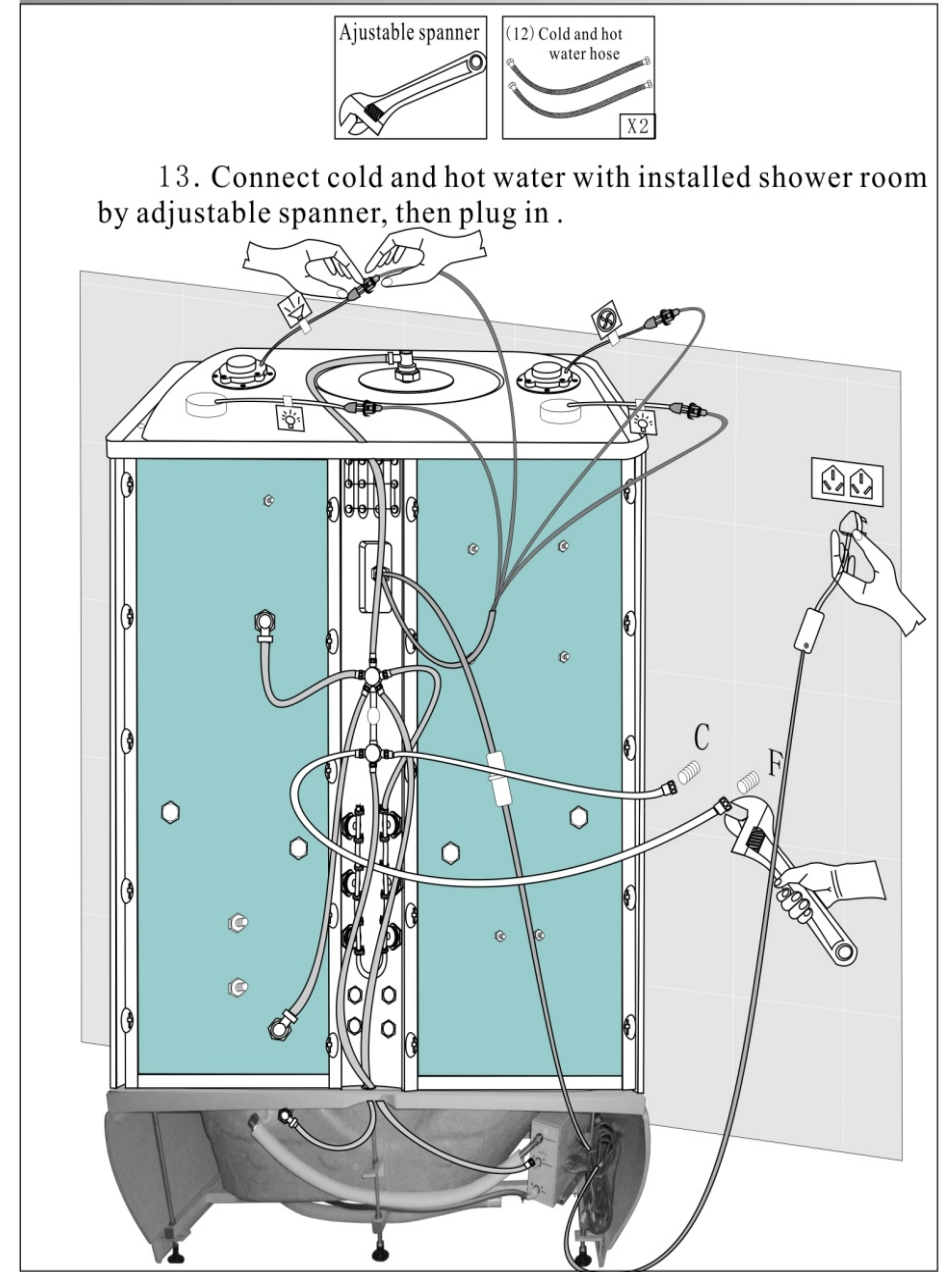

(20)

4. Installation Procedure

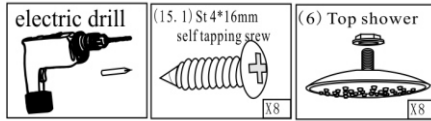

12.) Fix top cover with glass room by (15.1)ST4*16 screws.
Connect all of pipes and wires as picture.

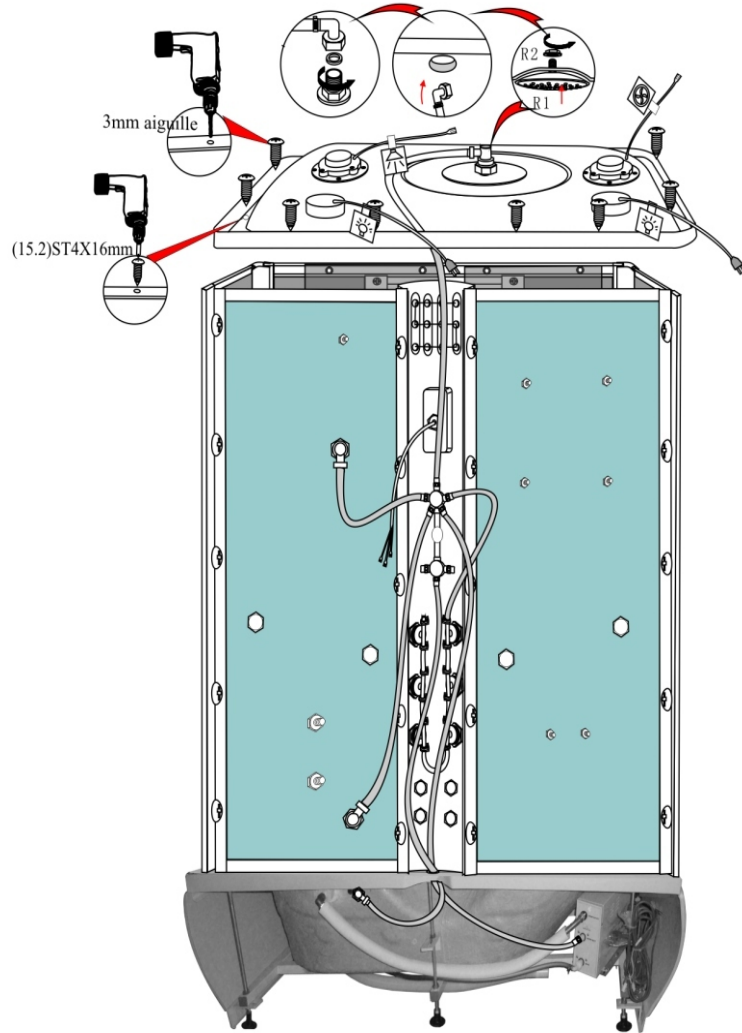







(19)

2. Partial accessory list

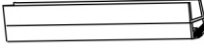
Item	Name	Accessory	Quantity
4	(4) Eccenter		8
5	(5) Knob		2
6	(6) Top shower		1
7	(7. 1) Handshower		1
	(7. 2) hand shower tube		1
8	(8) Lifting rod		1
9	(9) Foot massager		1
10	(10) Soap container		1
11	(11) Hand shower		1
12	(12) Cold and hot water hose		2

(4)

2. Partial accessory list

Item	Name	Accessory	Quantity
13	(13. 1) Magnetic strip		2
	(13. 2) Waterproof belt		2
	(13. 3) U style thong		4
14	(14) Glass positioning fixture		8
15	(15. 1) St 4*16mm self tapping screw		32
	(15. 2) St 4*10mm self tapping screw		12
	(16) Handrails		2

(5)

4. Installation Procedure

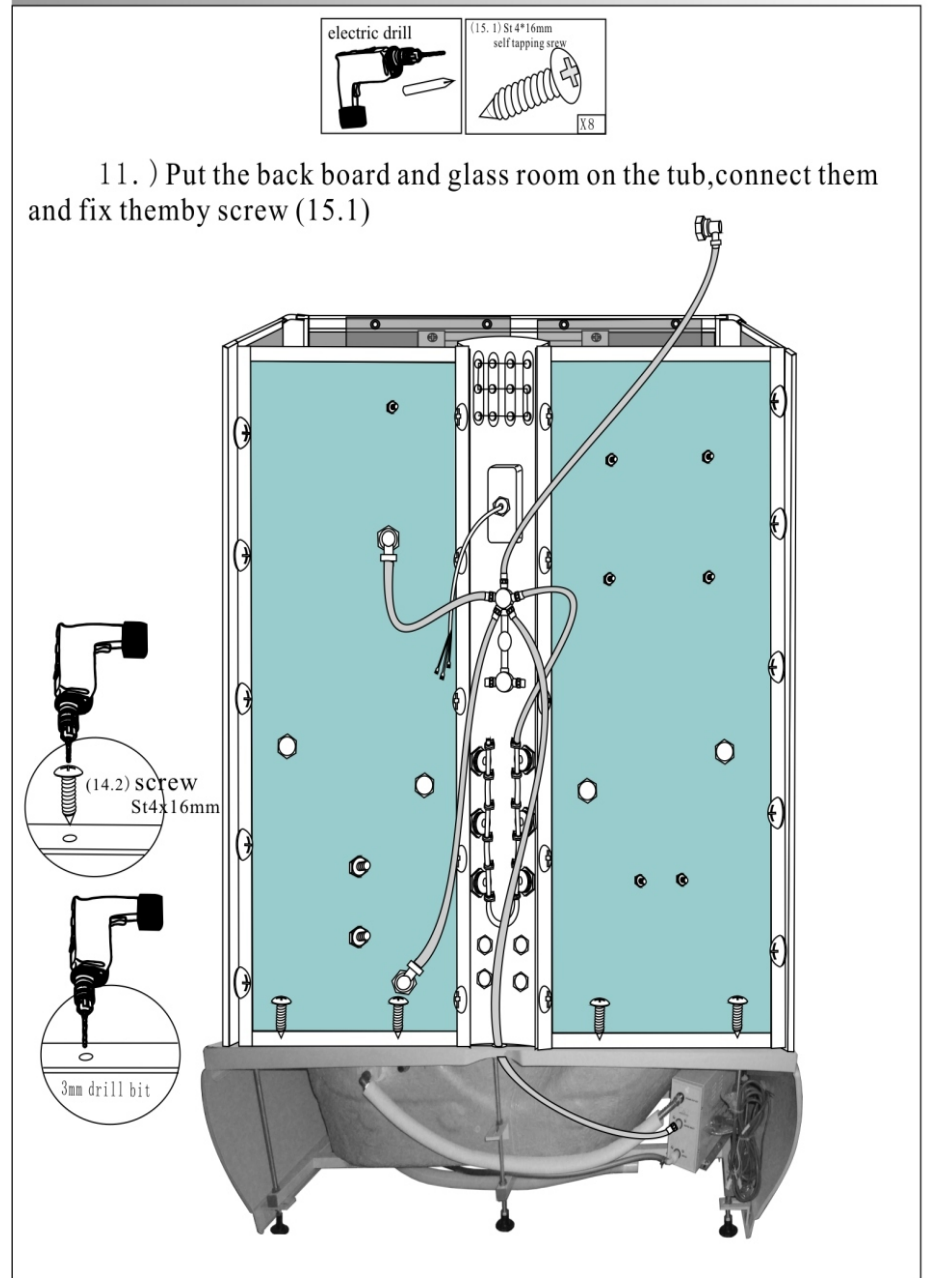

(18)

4. Installation Procedure

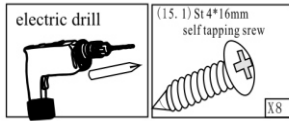

10.) Connect back board and glass room by screw (15.1), fit the pipes.

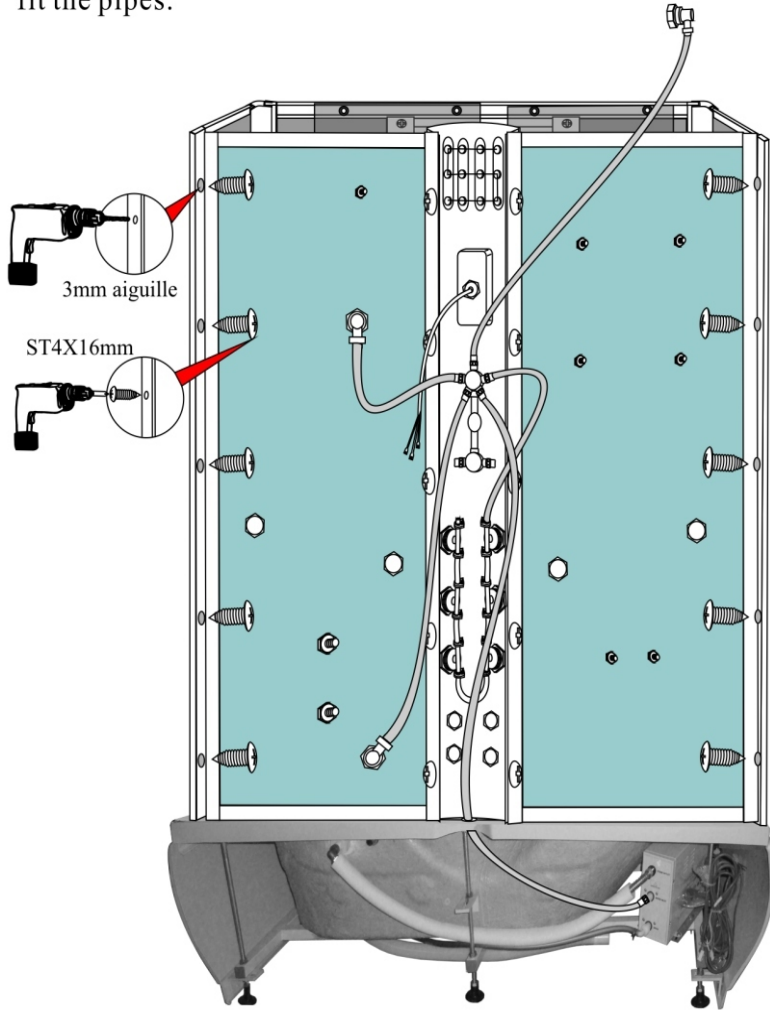

(17)

3. Pipe and drain installation drawing

Demension: 170*90*215cm

C=Cold water inlet

H=Hot water inlet

D=Drain



(6)

4. Installation Procedure

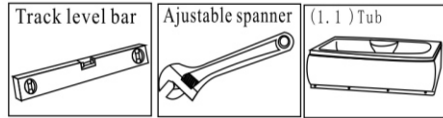

1.) Put track level bar on the tub, and adjust foot's screw by adjustable spanner, and keep it to the leveling

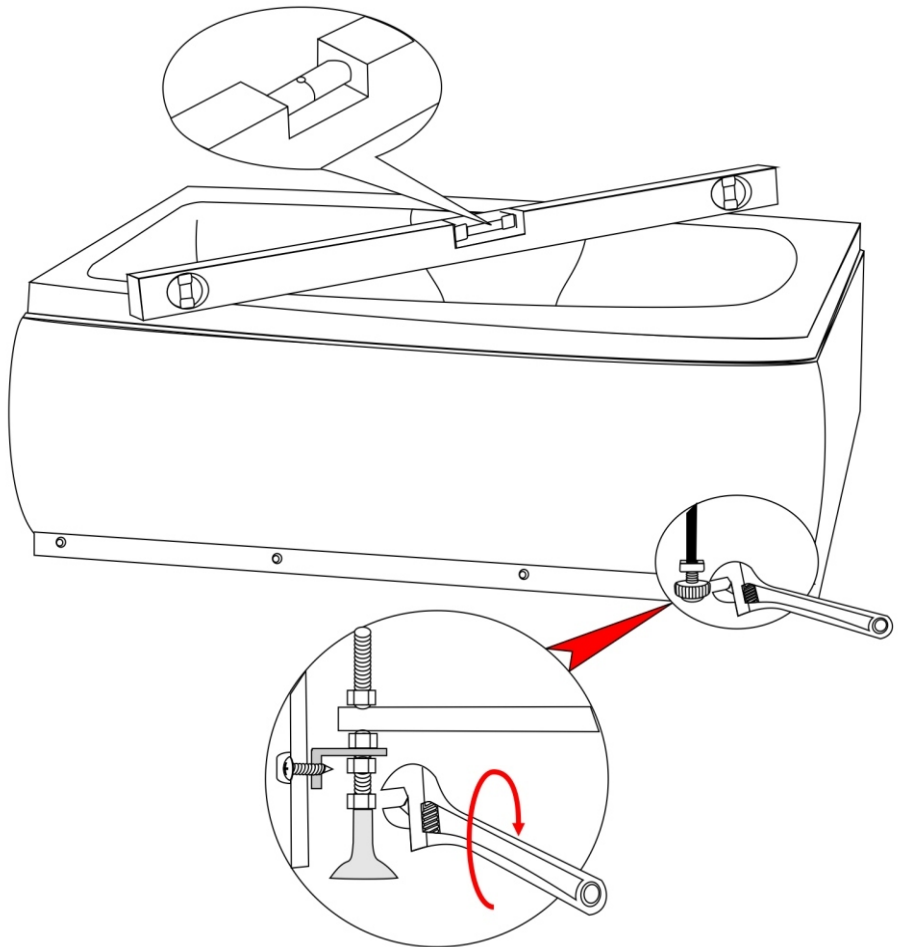

(7)

4. Installation Procedure

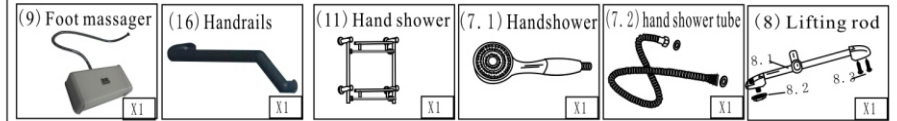

4.) Fit the soap container, handle shower, and glass holder.

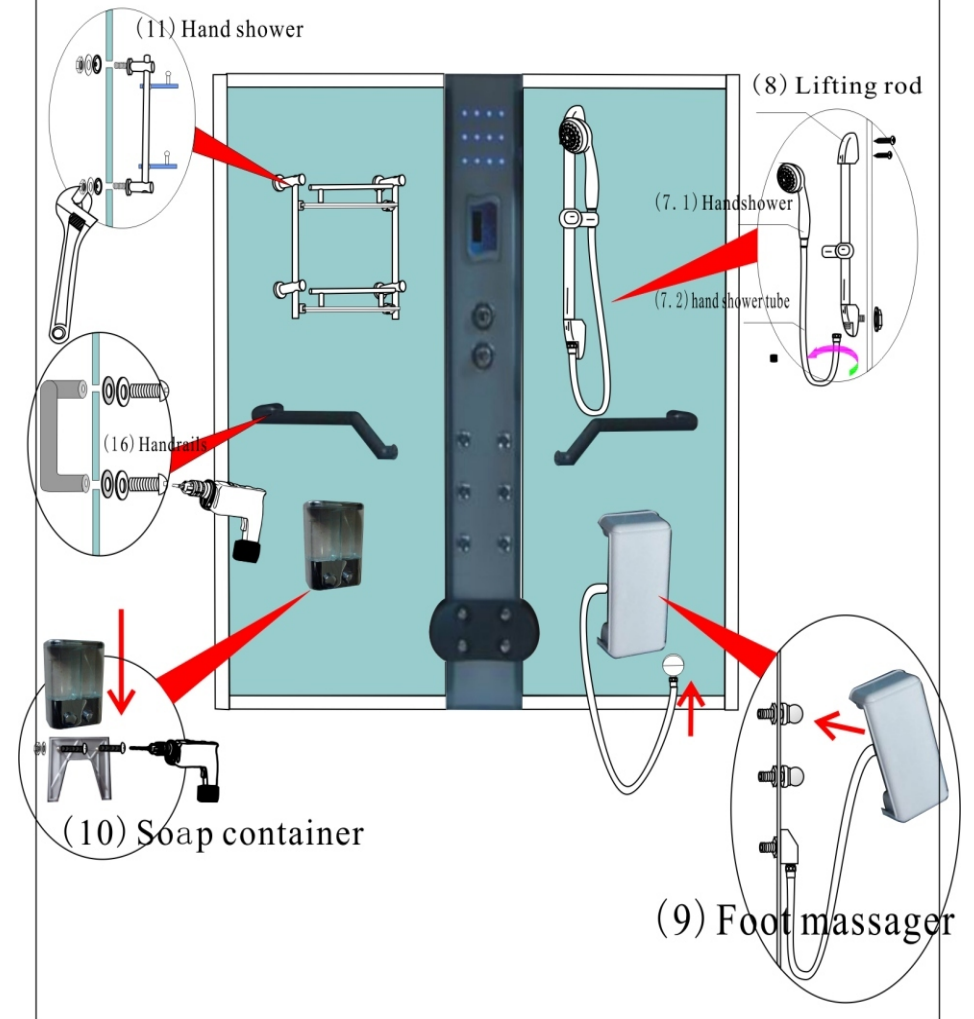

(16)

4. Installation Procedure

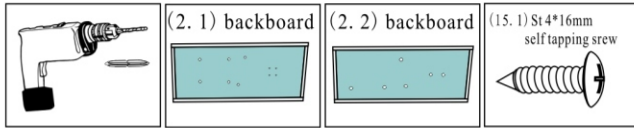

3.) Connect the aluminum panel and 2 pieces of back board glassby screws.

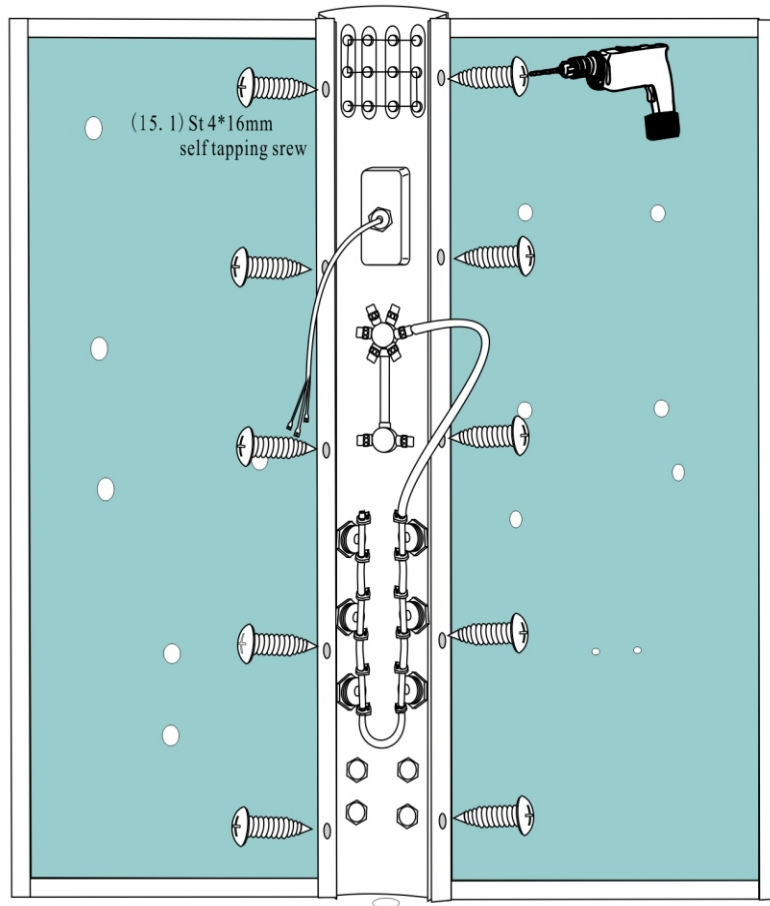

(15)

4. Installation Procedure

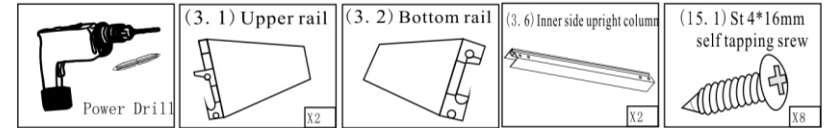

Build up the frame. Make sure the rails and upright aluminums are suitable. And find the difference between up rail and down rail.

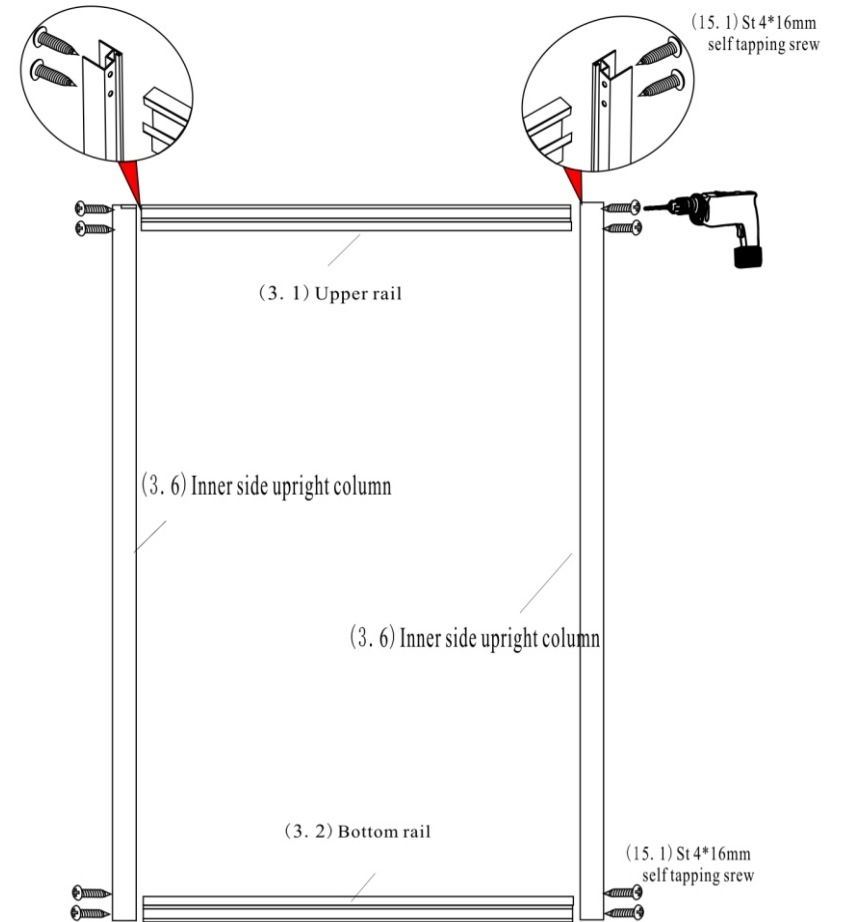

(8)

4. Installation Procedure

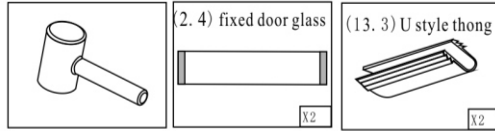

Fit the fixed glass into the frame, after fitting the rubber seal into glass one side, and then knock the glass carefully by hammer.

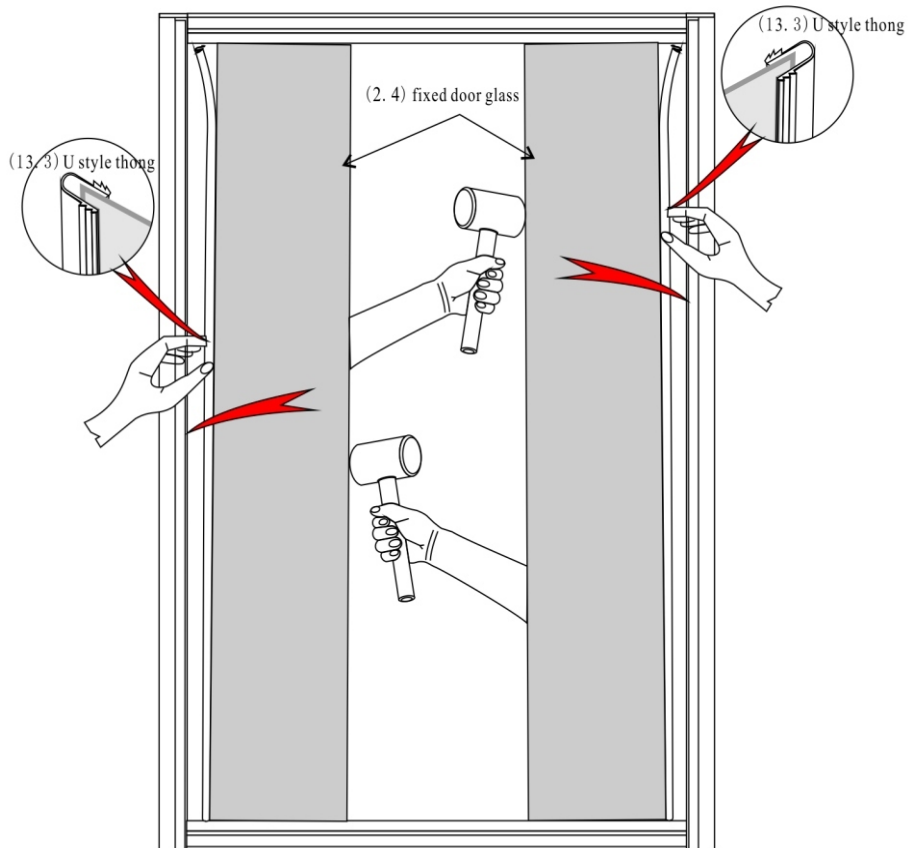

(9)

4. Installation Procedure

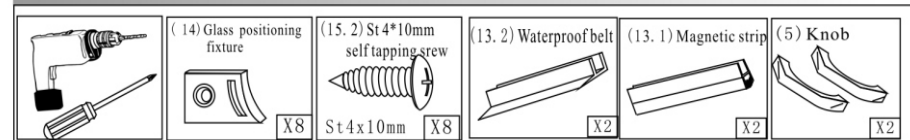

9.) Fit handle (5) into the door holes, fix them by its screws. Fix the location bar and magnetic seal, blocking water seal.

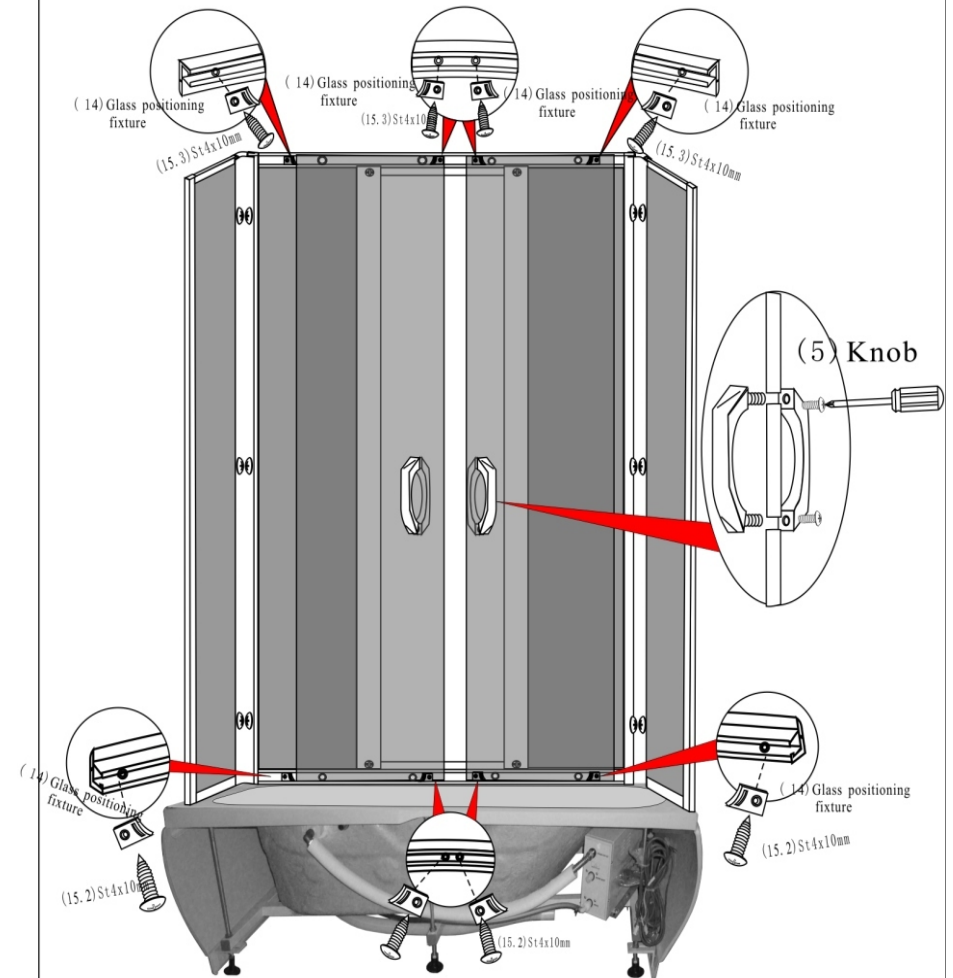

(14)

4. Installation Procedure

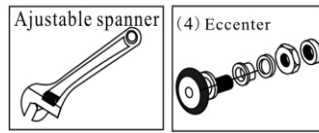

Put the roller(4) into glass door holes, and adjust the roller screw, then hang the door into up rails. Then fix all of roller, to make sure the door move smoothly.

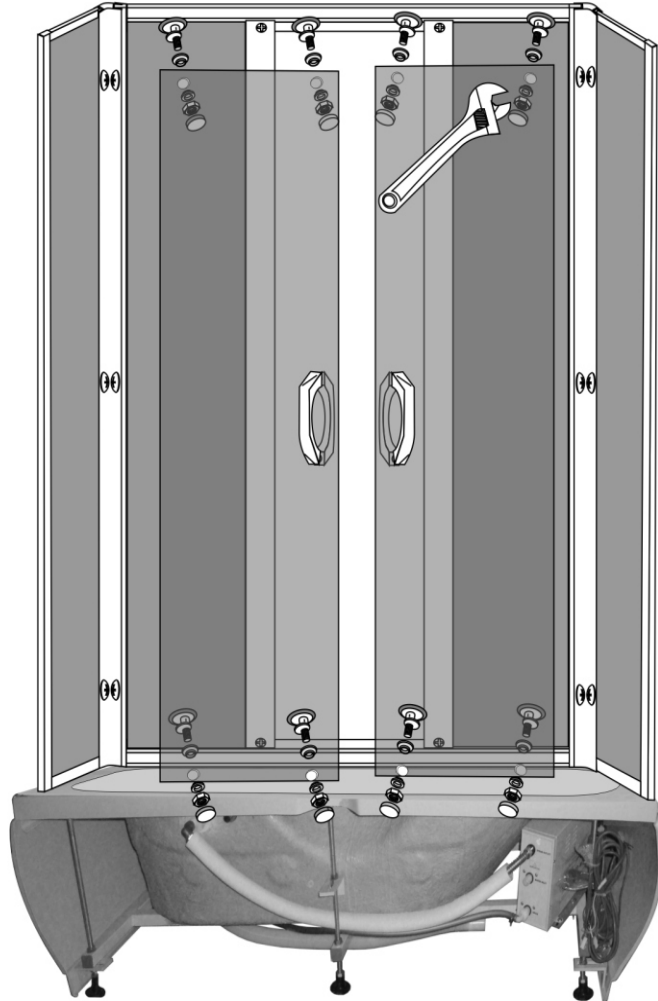

(13)

4. Installation Procedure

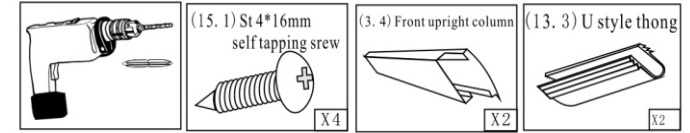

Fit U rubber seal to glass the other side, then use hammer to make the small aluminum panel(3.4) cover the glass. Then, fix the aluminum panel by screw(15.1)

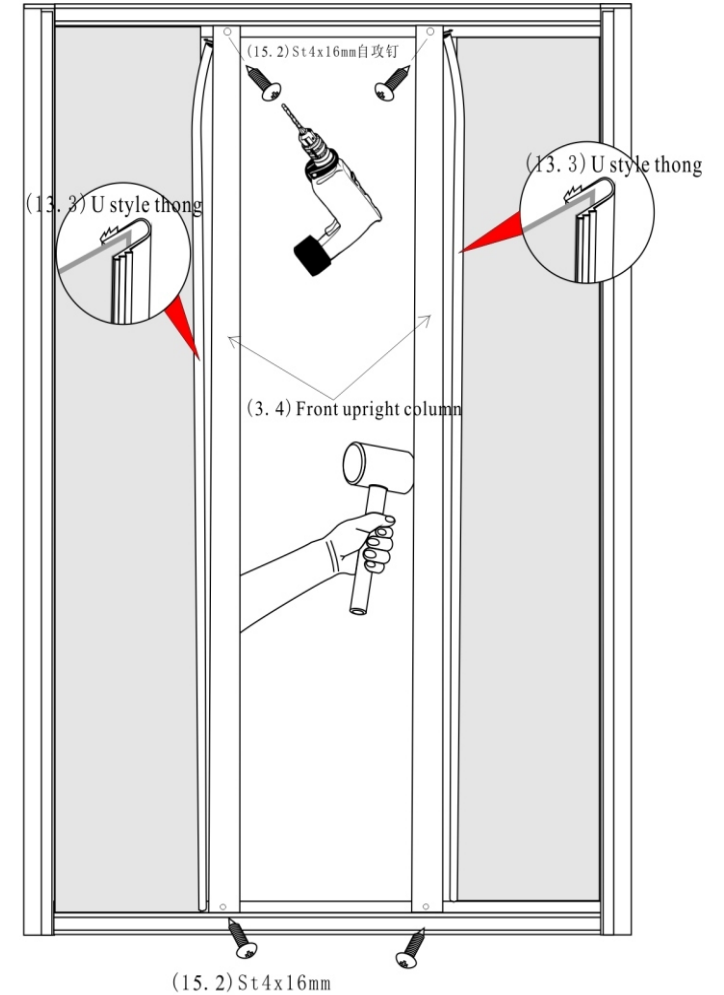

(10)

4. Installation Procedure

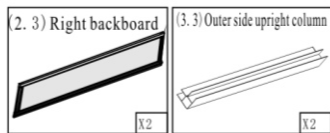

Connect the side glass with front glass frame(3.3)

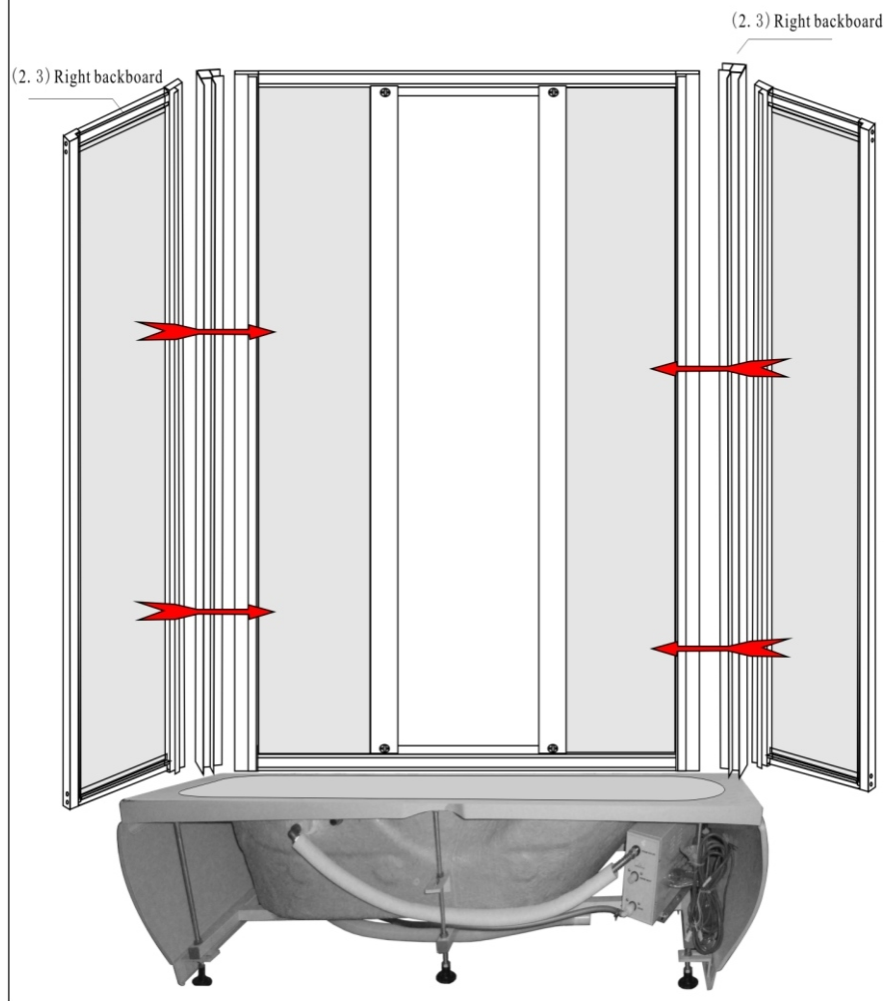

(11)

4. Installation Procedure

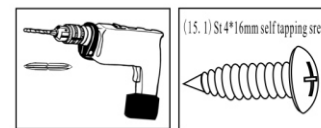

Fix the glass room by screw (15.2)

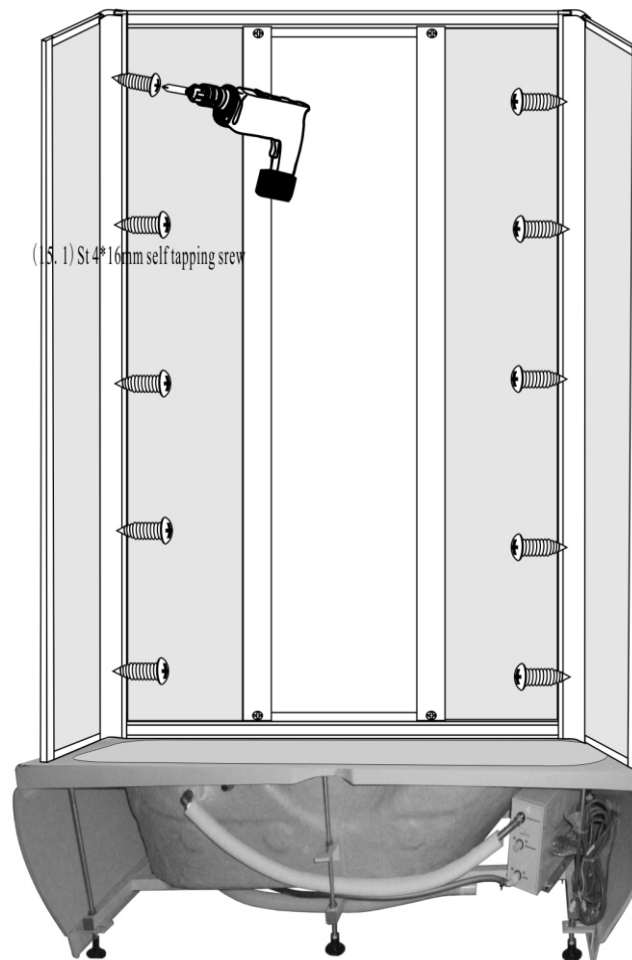

(12)